

Product Overview

Qorvo's QPA0506 is a MMIC power amplifier fabricated using Qorvo's QGaN25 0.25 μm GaN on SiC production process. Covering 5 – 6 GHz, the QPA0506 typically provides 36 dBm of saturated output power and 18 dB of large-signal gain while achieving 53 % power added efficiency.

The QPA0506 can support a range of bias voltages to optimize power and PAE to system requirements. The QPA0506 is matched to 50 ohms with a DC blocked input and a DC grounded output.

The QPA0506 is packaged in a plastic overmolded 4x4 mm package. The QPA0506 is 100% DC and RF tested to ensure compliance to electrical specifications.

Lead free and RoHS compliant.



Key Features

- Frequency Range: 5.0 – 6.0 GHz
- Output Power ($P_{IN} = 18 \text{ dBm}$): 36.5 dBm
- PAE ($P_{IN} = 18 \text{ dBm}$): 53 %
- Small Signal Gain: 27.4 dB
- Input Return Loss: 26 dB
- Output Return Loss: 11 dB
- Recommended Bias: $V_D = 25 \text{ V}$, $I_{DQ} = 37.5 \text{ mA}$
- Package Size: 4.0 mm x 4.0 mm x 0.85 mm

Functional Block Diagram

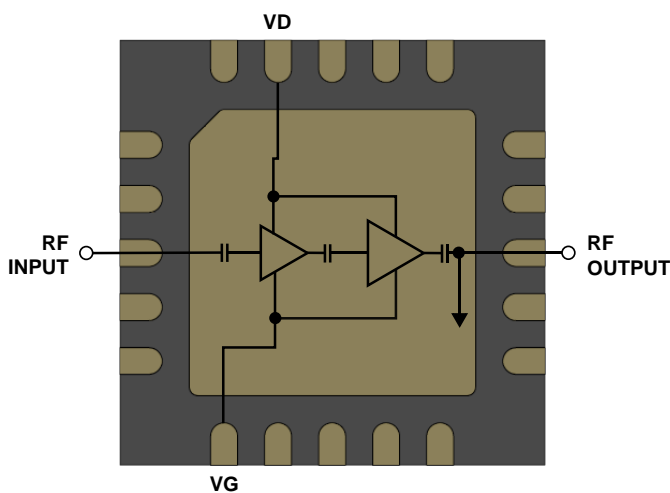

Top View

Applications

- Radar
- Communications
- Satcom

Ordering Information

Part No.	Description
QPA0506	4 Watt X-Band Power Amplifier
QPA0506TR7	250 pcs. on 7 inch reel
QPA0506EVB	QPA0506 Evaluation Board

Absolute Maximum Ratings

Parameter	Rating
Drain Voltage (V_D)	40 V
Gate Voltage Range (V_G)	-5 to 0 V
Drain Current (I_D)	540 mA
Gate Current (I_G)	See plot pg. 12
Power Dissipation (P_{DISS}), $T_{BASE} = 85\text{ }^\circ\text{C}$	26 W
Input Power (P_{IN}), Pulse (100us/10%), 50 Ω , 24 V, $T_{BASE} = 85\text{ }^\circ\text{C}$	25 dBm
Input Power (P_{IN}), Pulse (100us/10%), VSWR 3:1, $V_D = 24\text{ V}$, $T_{BASE} = 85\text{ }^\circ\text{C}$	23 dBm
Mounting Temperature (30 seconds max.)	260 $^\circ\text{C}$
Storage Temperature	-55 to 125 $^\circ\text{C}$

Exceeding any one or a combination of the Absolute Maximum Rating conditions may cause permanent damage to the device. Extended application of Absolute Maximum Rating conditions to the device may reduce device reliability.

Recommended Operating Conditions

Parameter	Typ
Drain Voltage (V_D)	25 V
Drain Current (I_{DQ})	37.5 mA
Drain Current Under RF Drive (I_{D_DRIVE})	See pgs. 4-7
Gate Voltage Range (V_G)	-2.8 to -2.0 V
Gate Current Under RF Drive (I_{G_DRIVE})	See pgs. 4-5

Electrical specifications are measured at specified test conditions. Specifications are not guaranteed over all recommended operating conditions.

Electrical Specifications

Parameter	Conditions	Min	Typ	Max	Units
Operational Frequency		5		6	GHz
Output Power ($P_{IN} = 18\text{ dBm}$)	Pulsed V_D		36.5		dBm
Power Added Efficiency ($P_{IN} = 18\text{ dBm}$)	Pulsed V_D		53.0		%
Small Signal Gain	CW		27.4		dB
Input Return Loss	CW		26		dB
Output Return Loss	CW		11		dB
3 RD Order IMD ($P_{OUT}/\text{Tone} = 24\text{ dBm}$)	10 MHz tone spacing		-27		dBc
2 nd Harmonic ($P_{IN} = 18\text{ dBm}$)			-25		dBc
3 rd Harmonic ($P_{IN} = 18\text{ dBm}$)			-39		dBc
P_{OUT} Temp. Coeff. (85 $^\circ\text{C}$ to 25 $^\circ\text{C}$, $P_{IN} = 18\text{ dBm}$)	Pulsed V_D		-0.007		dB/ $^\circ\text{C}$
Sm. Sig. Gain Temp. Coefficient (85 $^\circ\text{C}$ to -40 $^\circ\text{C}$)	CW		-0.046		dB/ $^\circ\text{C}$
Gate Leakage Current	$V_D = 10\text{ V}$, $V_G = -3.7\text{ V}$	-1.85			mA

Test conditions, unless otherwise noted: $T = +25\text{ }^\circ\text{C}$, $V_D = 25\text{ V}$, $I_{DQ} = 37.5\text{ mA}$, $PW = 100\text{ us}$, Duty Cycle = 10%

Performance Plots – Large Signal (Pulsed)

Test conditions unless otherwise noted: T = +25 °C, V_D = 25 V, I_{DQ} = 37.5 mA, P_{IN} = 18 dBm, PW = 100 us, Duty Cycle = 10%

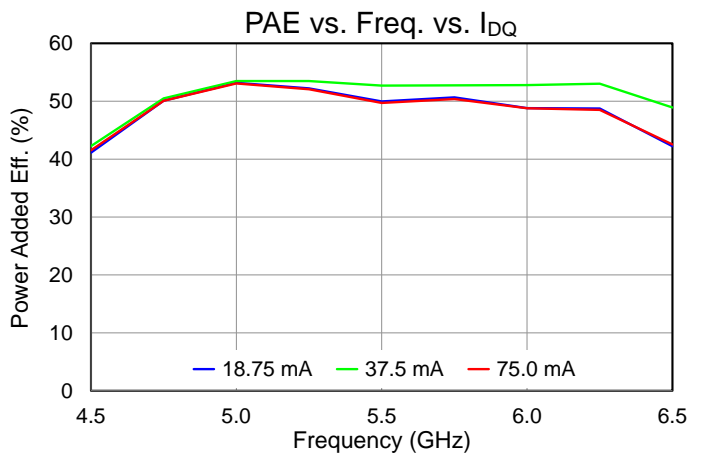
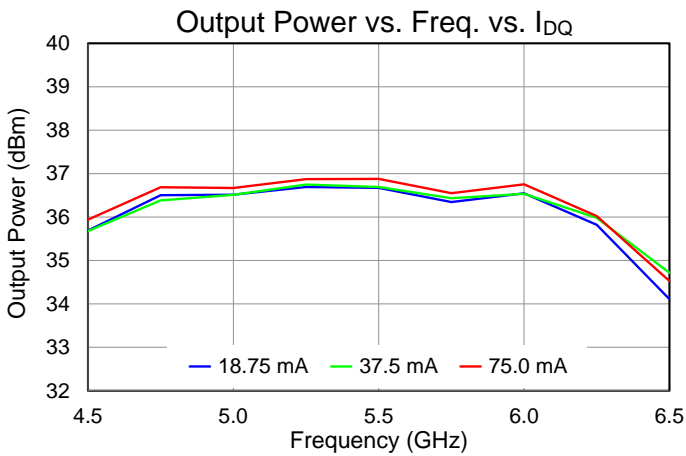
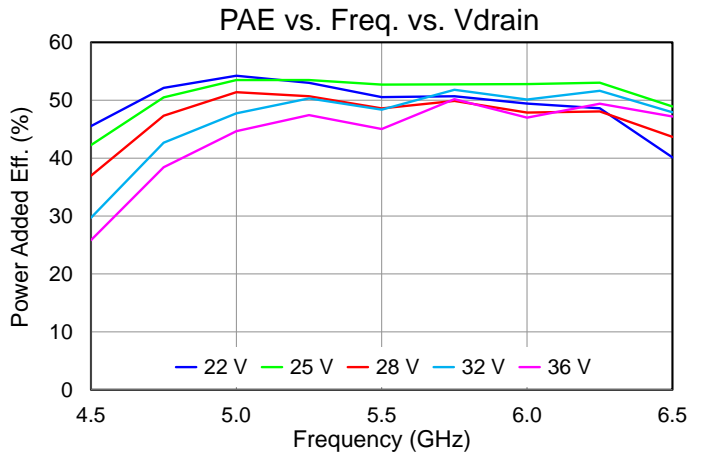
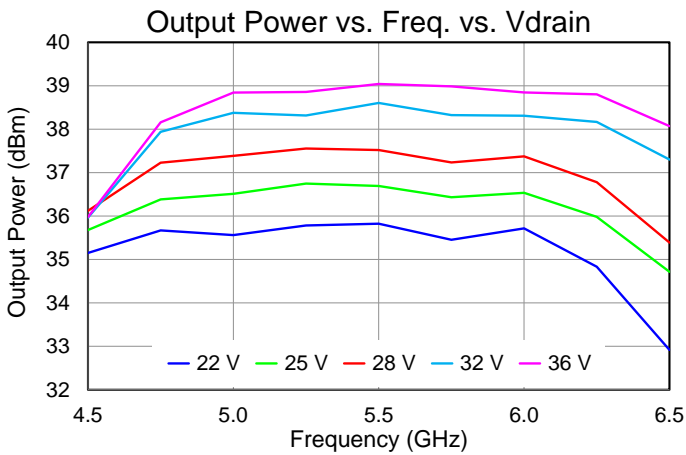
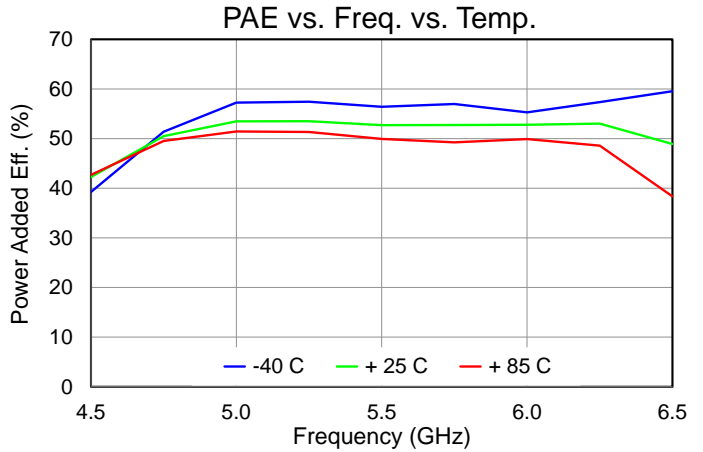
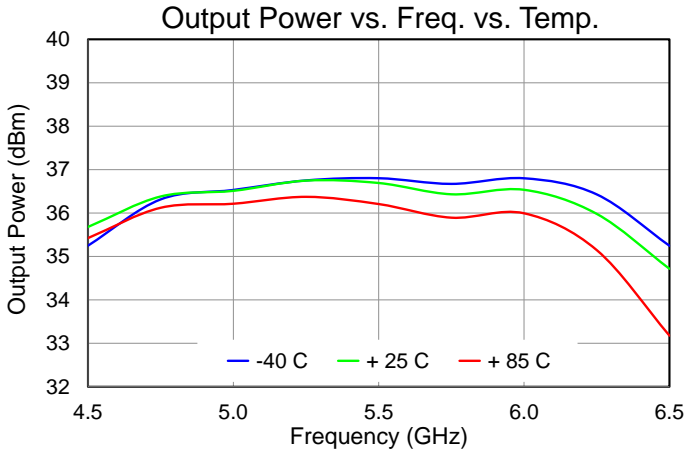

Performance Plots – Large Signal (Pulsed)

Test conditions unless otherwise noted: $T = +25\text{ }^{\circ}\text{C}$, $V_D = 25\text{ V}$, $I_{DQ} = 37.5\text{ mA}$, $P_{IN} = 18\text{ dBm}$, $PW = 100\text{ }\mu\text{s}$, Duty Cycle = 10%

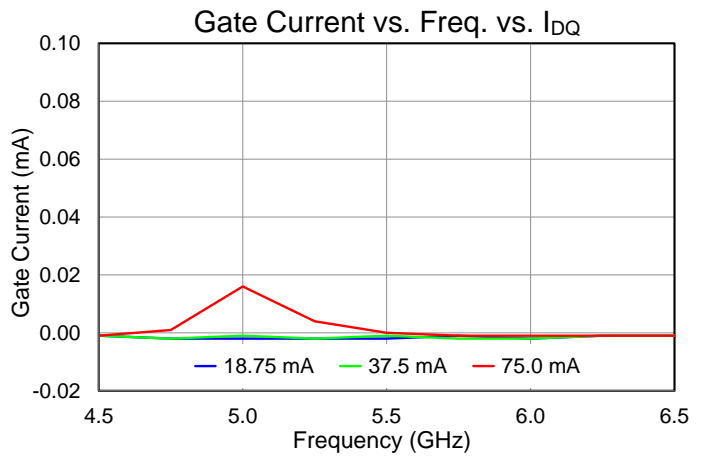
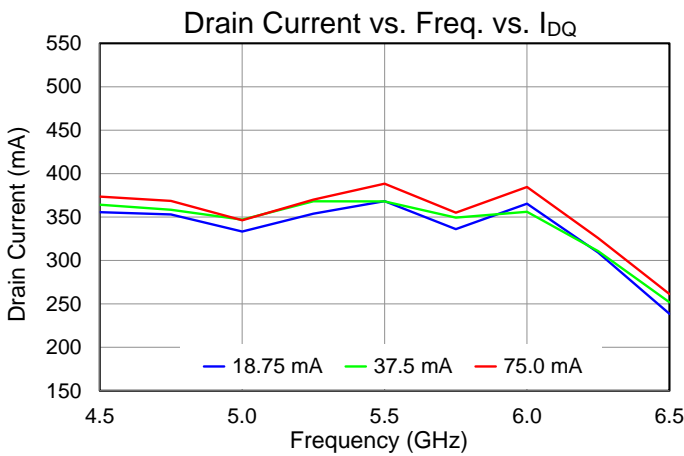
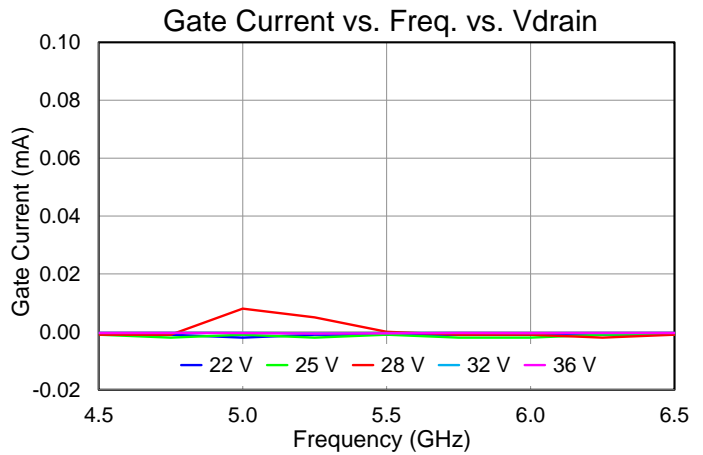
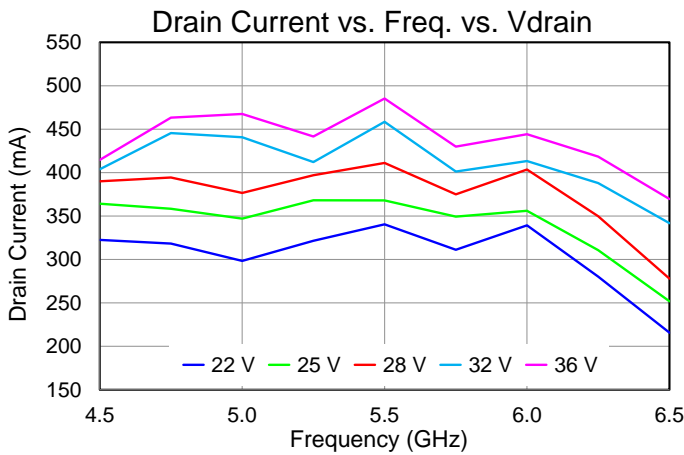
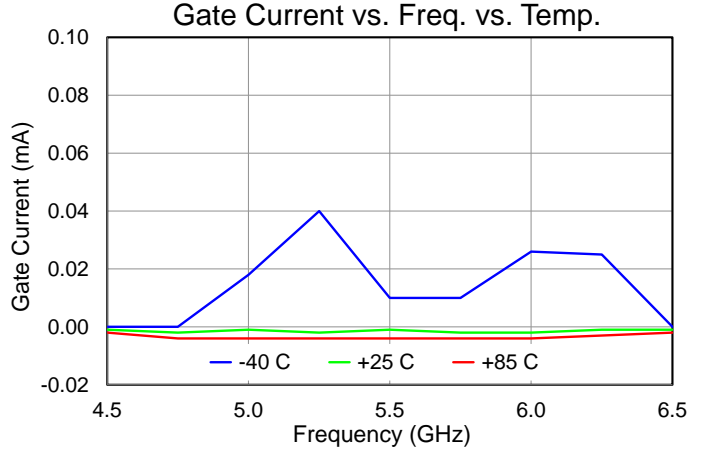
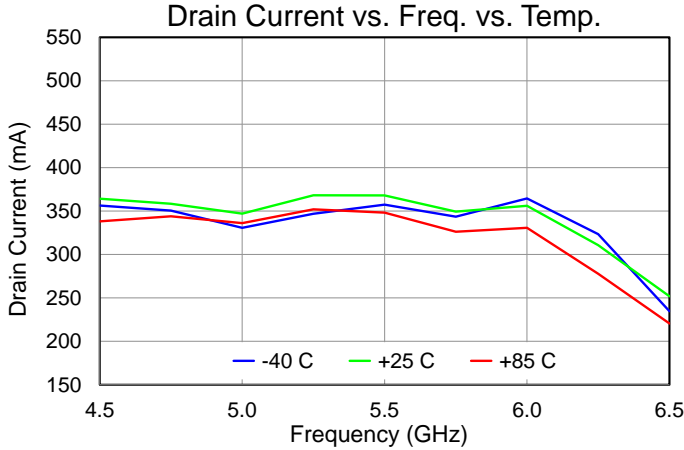

Performance Plots – Large Signal (Pulsed)

Test conditions unless otherwise noted: $T = +25\text{ }^{\circ}\text{C}$, $V_D = 25\text{ V}$, $I_{DQ} = 37.5\text{ mA}$, $PW = 100\text{ }\mu\text{s}$, Duty Cycle = 10%

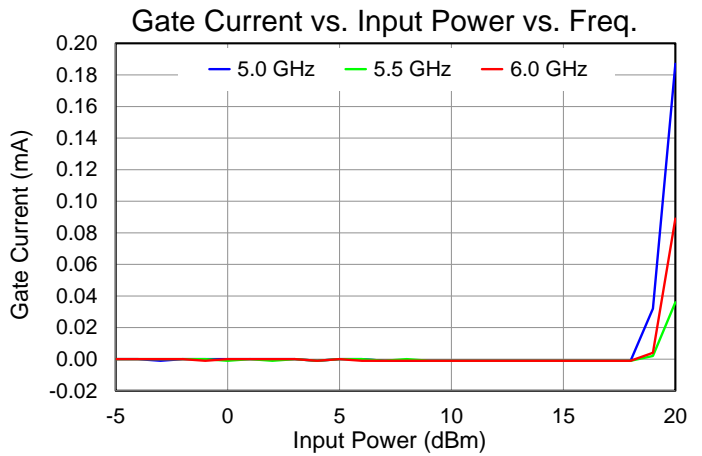
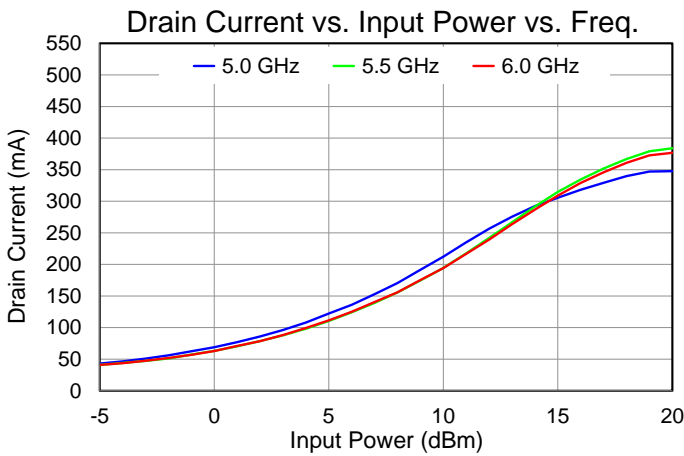
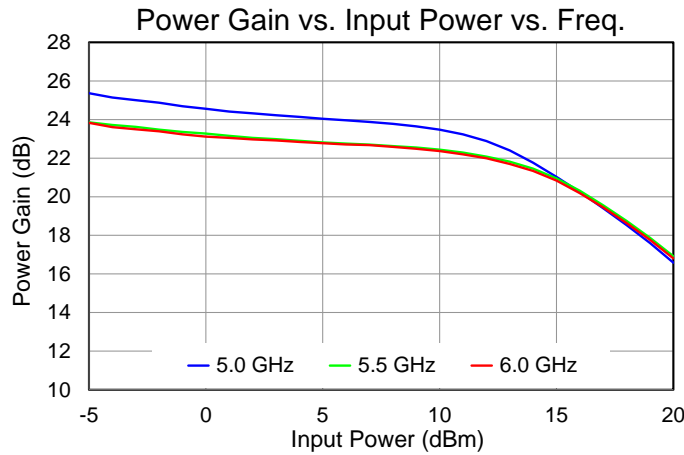
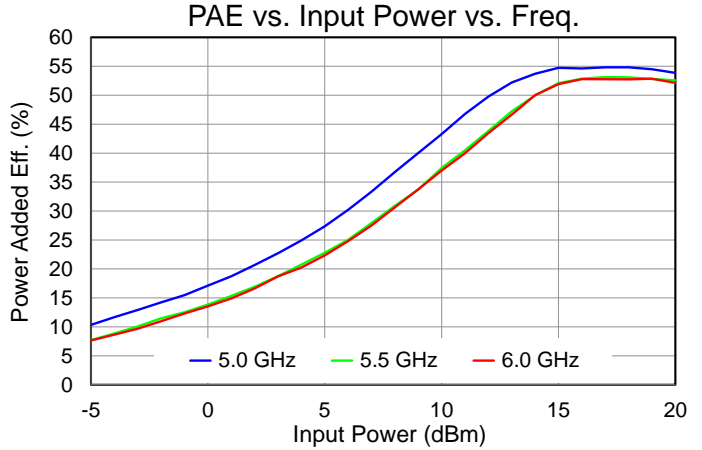
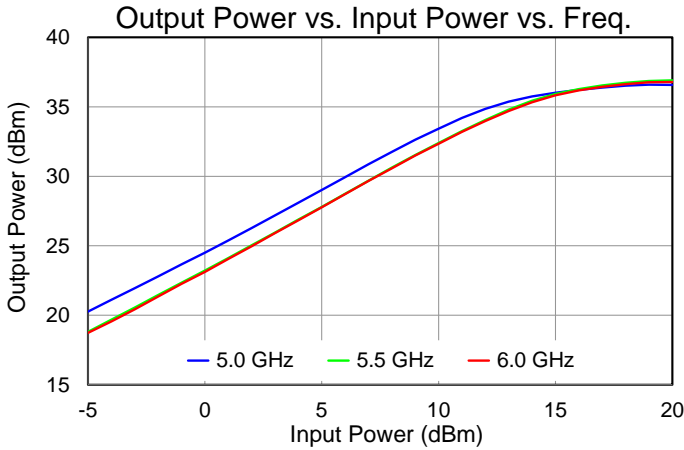

Performance Plots – Large Signal (Pulsed)

Test conditions unless otherwise noted: T = +25 °C, V_D = 25 V, I_{BQ} = 37.5 mA, PW = 100 us, Duty Cycle = 10%

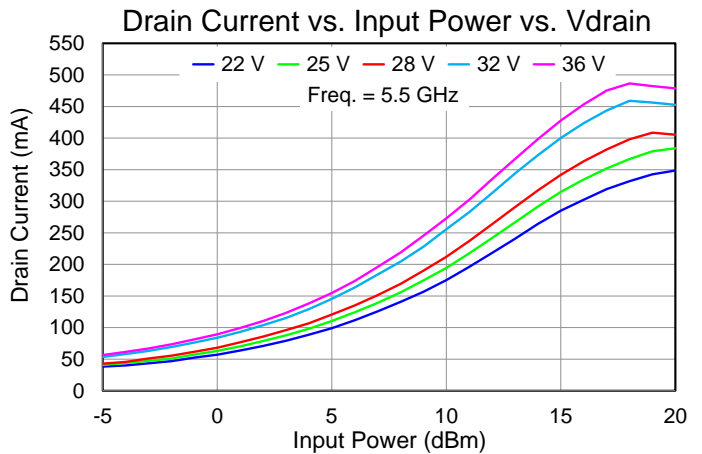
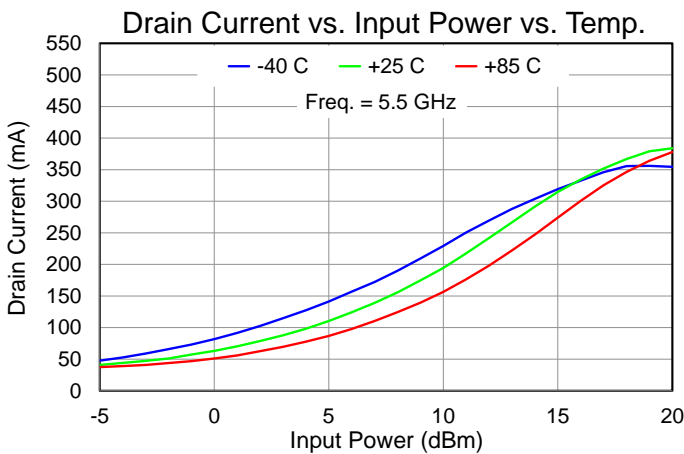
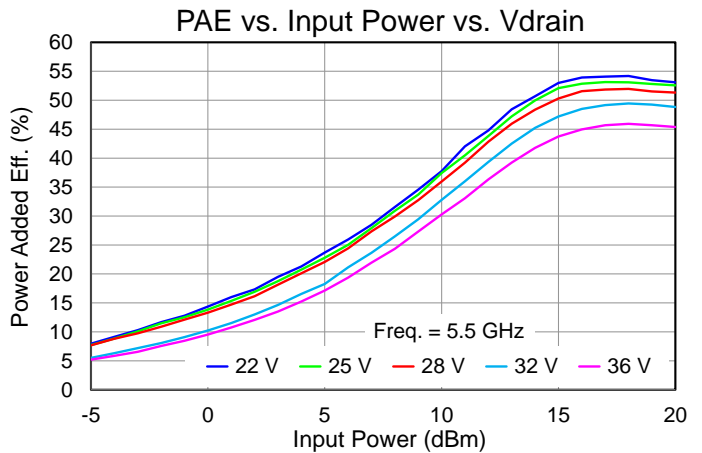
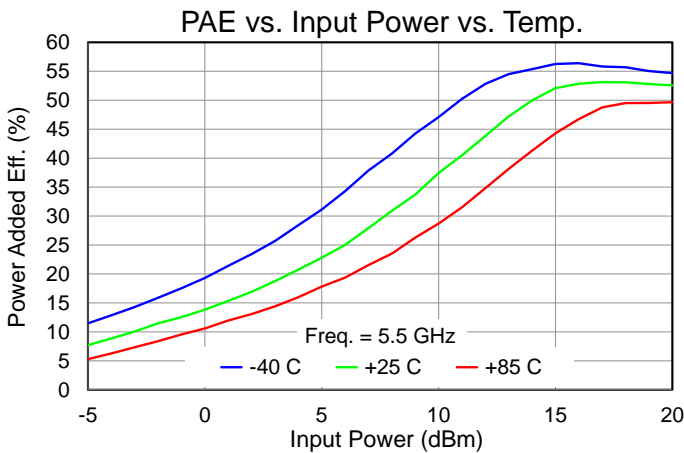
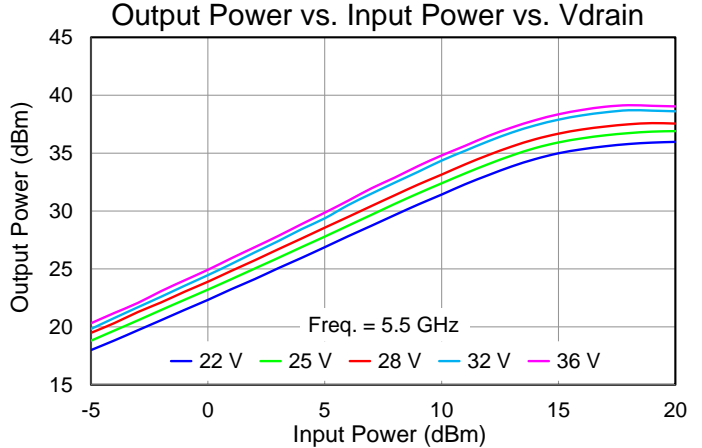
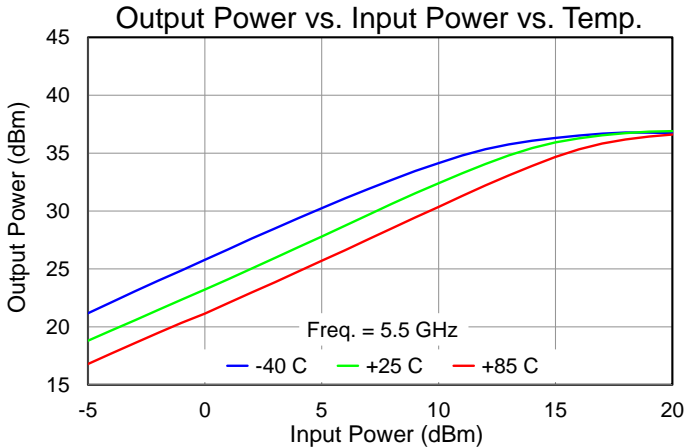

Performance Plots – Large Signal (Pulsed)

Test conditions unless otherwise noted: T = +25 °C, V_D = 25 V, I_{DQ} = 37.5 mA, PW = 100 us, Duty Cycle = 10%

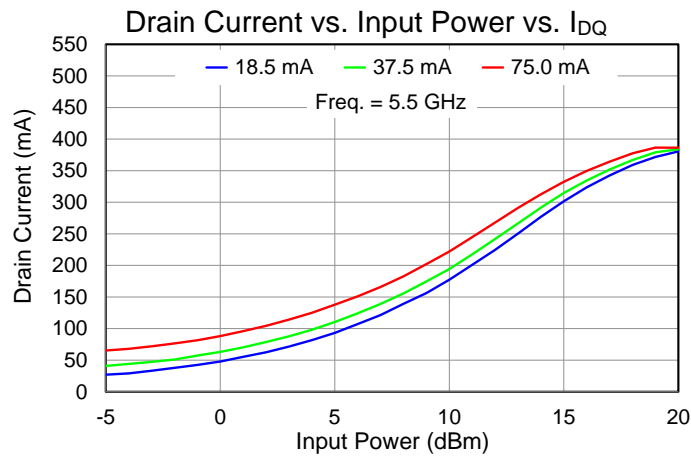
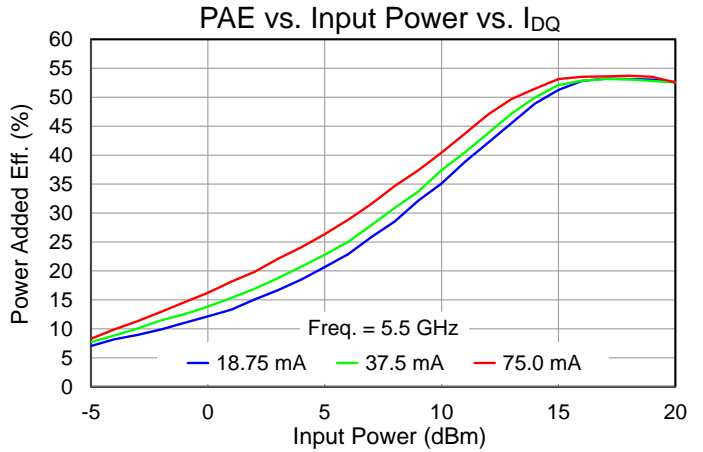
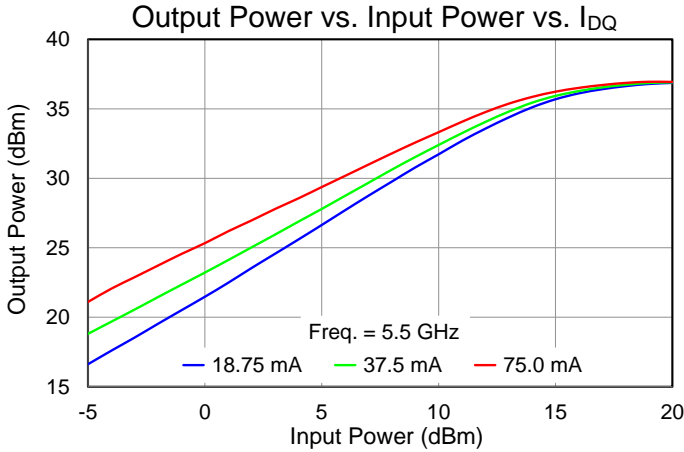

Performance Plots – Linearity

Test conditions unless otherwise noted: $V_D = 25\text{ V}$, $I_{DQ} = 37.5\text{ mA}$, $T = 25\text{ }^\circ\text{C}$, 10 MHz Tone Spacing, CW

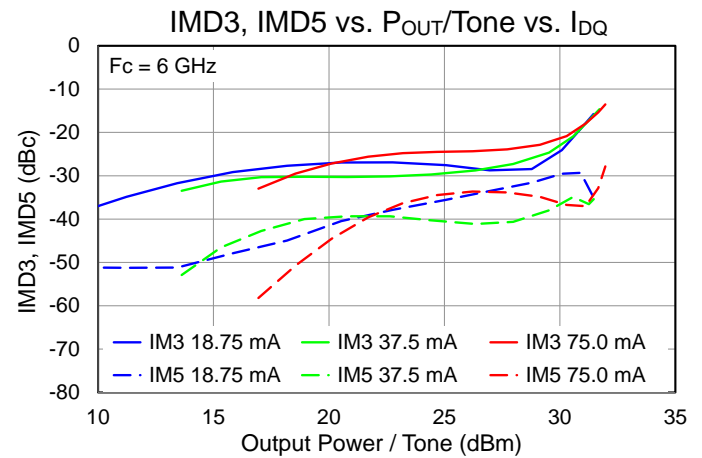
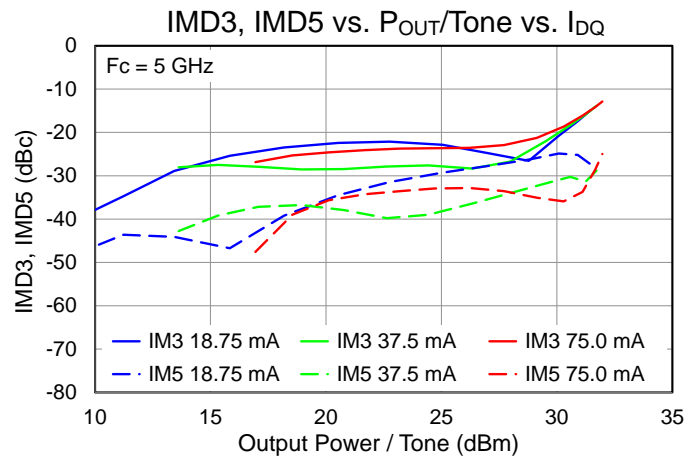
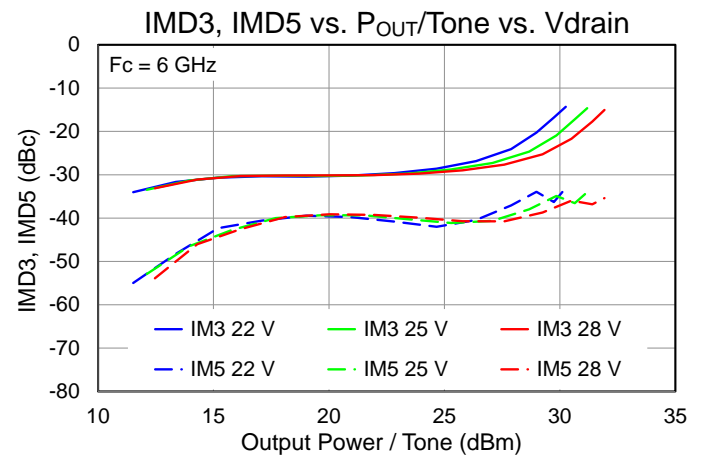
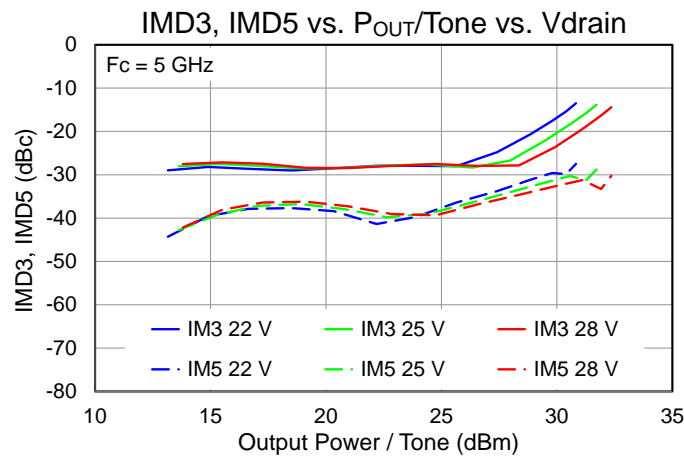
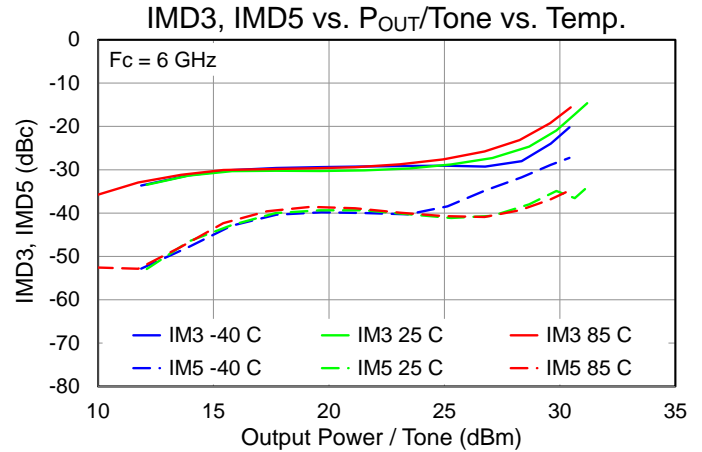
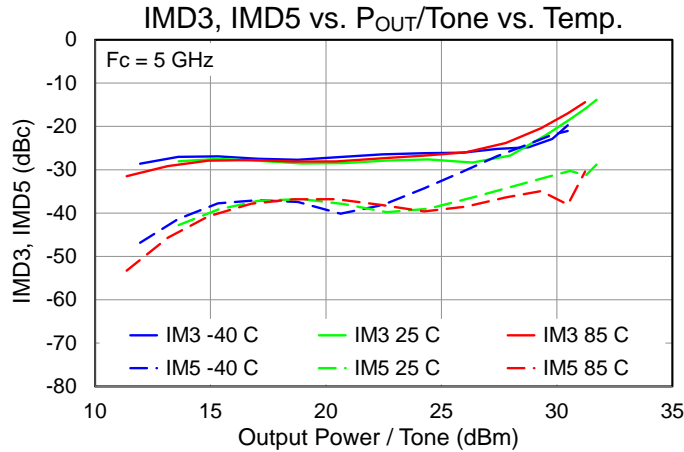

Performance Plots – Harmonics

Test conditions unless otherwise noted: T = +25 °C, V_D = 25 V, I_{BQ} = 37.5 mA, PW = 100 us, Duty Cycle = 10%

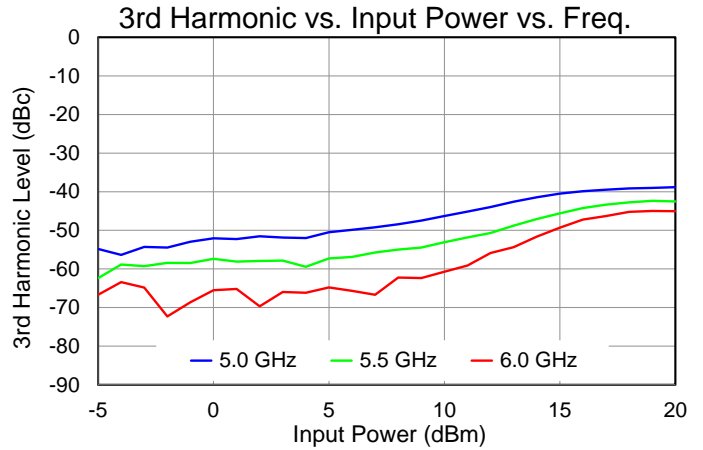
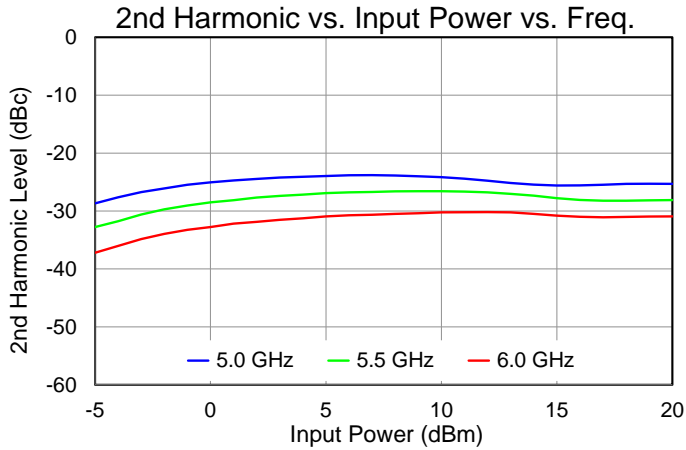

Performance Plots – Small Signal

Test conditions unless otherwise noted: T = +25 °C, V_D = 25 V, I_{BQ} = 37.5 mA, CW

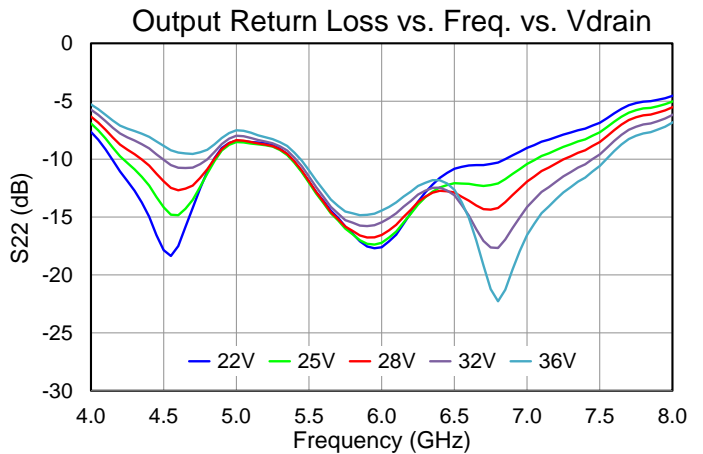
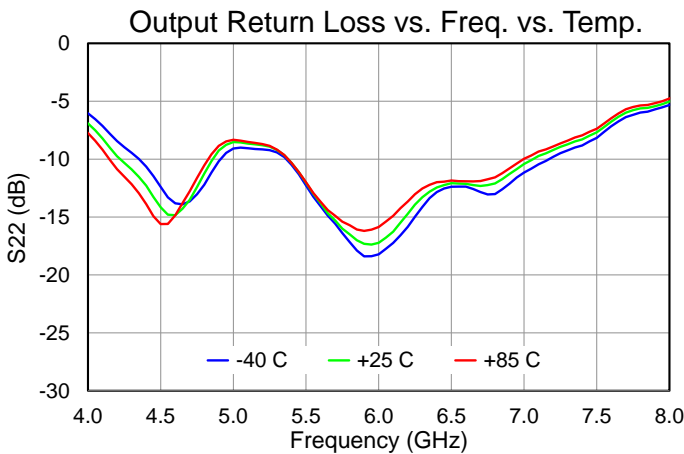
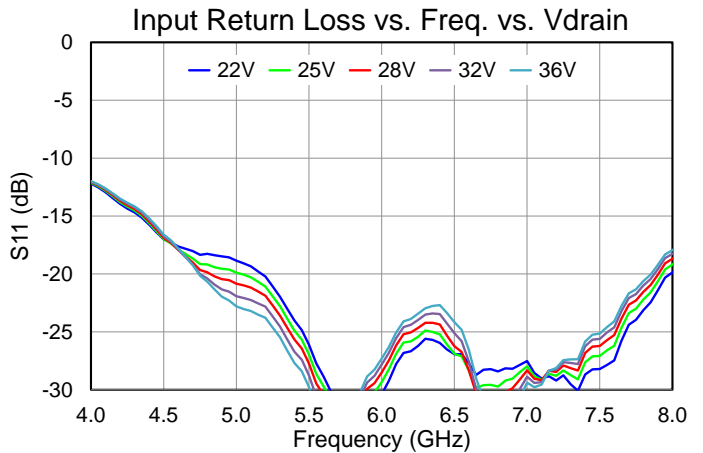
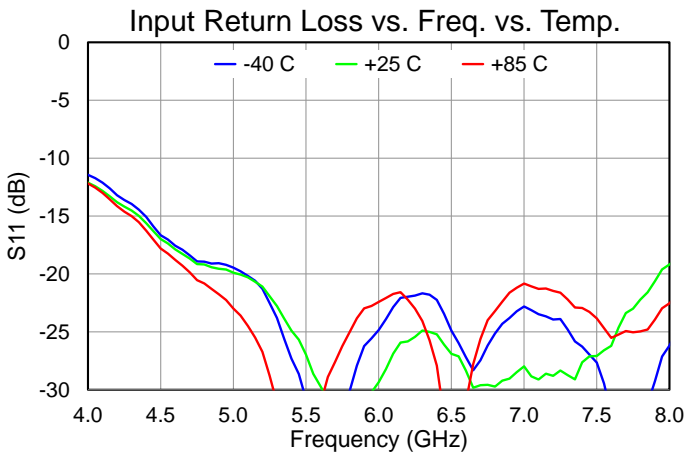
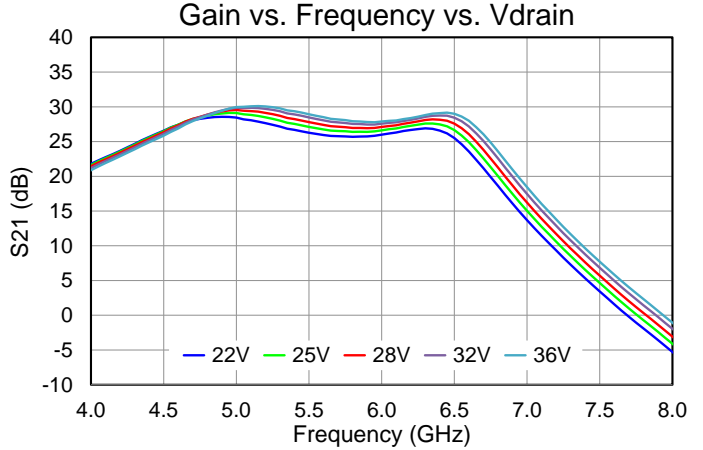
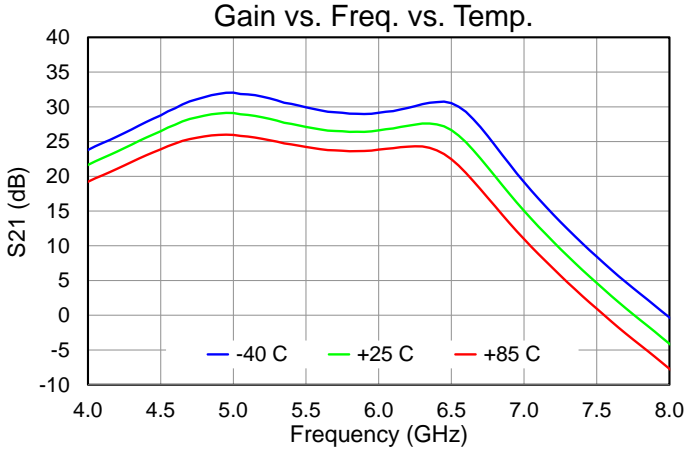

Performance Plots – Small Signal

Test conditions unless otherwise noted: T = +25 °C, V_D = 25 V, I_{DQ} = 37.5 mA, CW

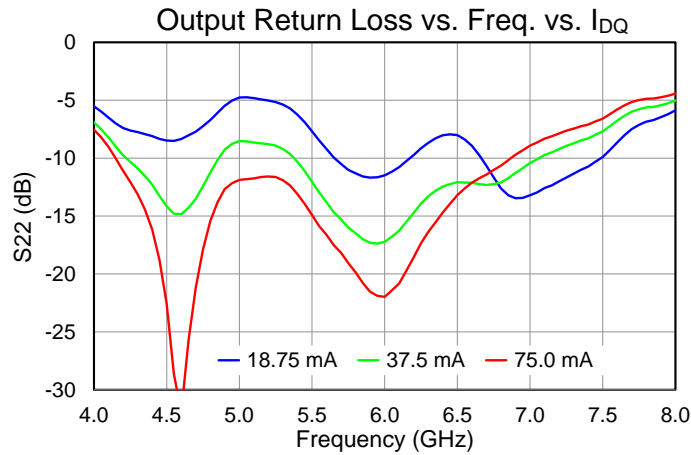
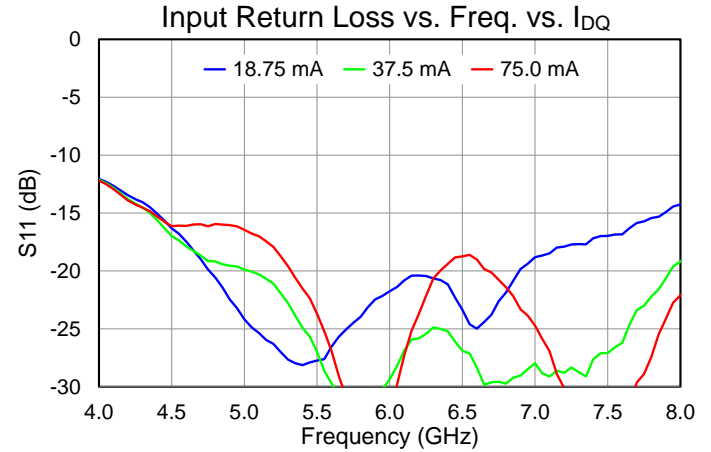
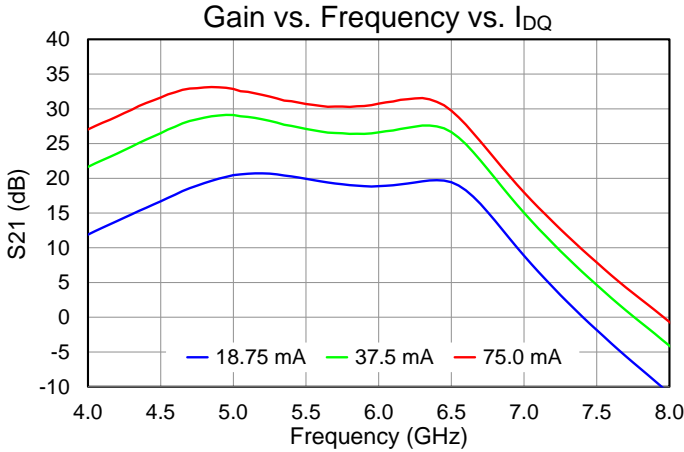

Thermal and Reliability Information

Parameter	Test Conditions	Value	Units
Thermal Resistance (θ_{JC}) ⁽¹⁾	$T_{base} = +85\text{ }^{\circ}\text{C}$, $V_D = 25\text{ V}$, $I_{DQ} = 37.5\text{ mA}$, $I_{D_Drive} = 348\text{ mA}$, $P_{OUT} = 36.2\text{ dBm}$, $P_{IN} = 18\text{ dBm}$, Freq. = 5.5 GHz, $P_{DISS} = 4.13\text{ W}$ (Pulse: 100us/10%)	6.281	$^{\circ}\text{C/W}$
Channel Temperature, T_{CH} (Under RF) ⁽²⁾		110.9	$^{\circ}\text{C}$

Notes:

1. Thermal resistance is referenced to the back of the package.
2. IR scan equivalent temperatures. Refer to the following document: [GaN Device Channel Temperature, Thermal Resistance, and Reliability Estimates](#)

Power Dissipation and Maximum Gate Current

$P_{IN} = 18\text{ dBm}$, $PW = 100\text{ }\mu\text{s}$, Duty Cycle = 10%

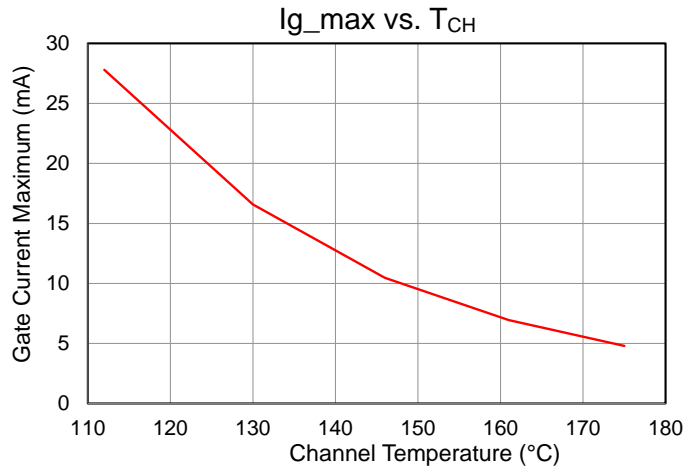
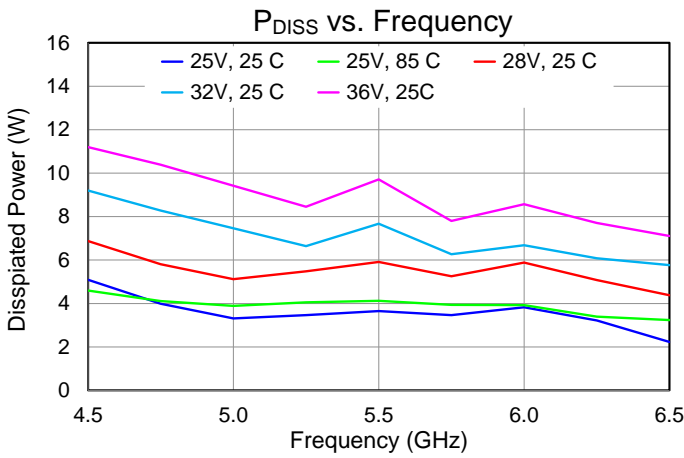

Application Information

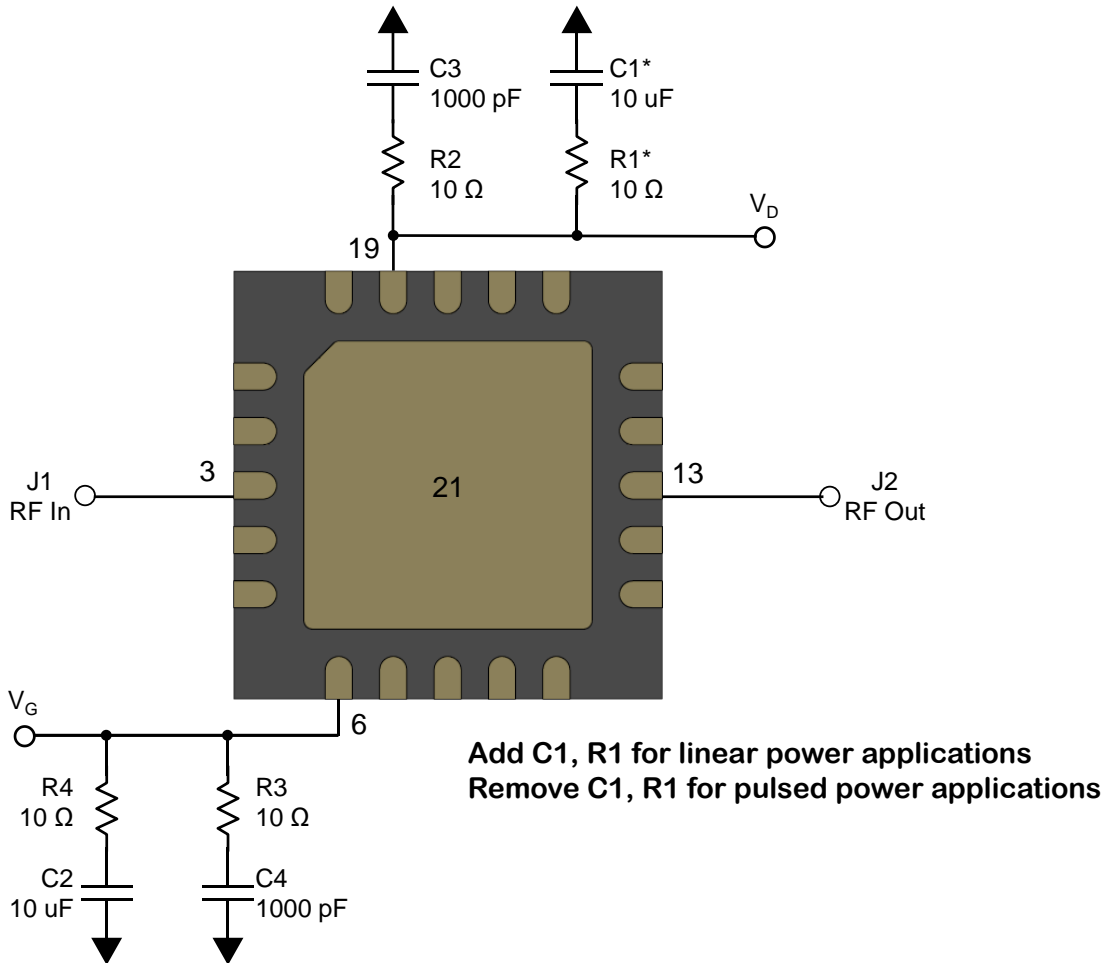

Bias-up Procedure

- Set I_D limit to 600 mA, I_G limit to 5 mA

- Apply -5 V to V_G

- Apply +25 V to V_D ; ensure I_{DQ} is approx. 0 mA

- Adjust V_G until $I_{DQ} = 37.5$ mA

- Turn on RF supply

Bias-down Procedure

- Turn off RF signal

- Reduce V_G to -5 V; ensure I_{DQ} is approx. 0 mA

- Set V_D to 0 V

- Turn off V_D supply

- Turn off V_G supply

Pin Layout

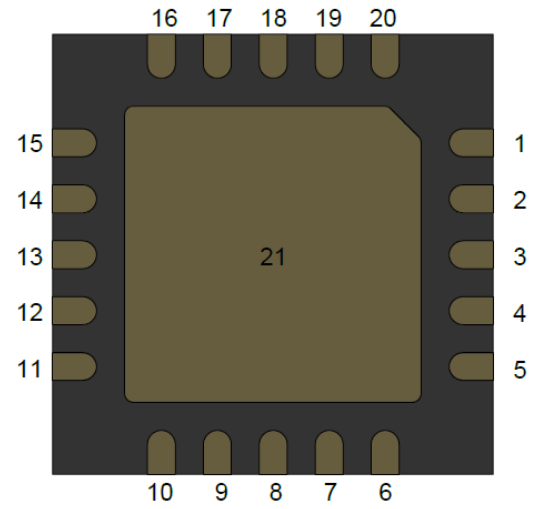
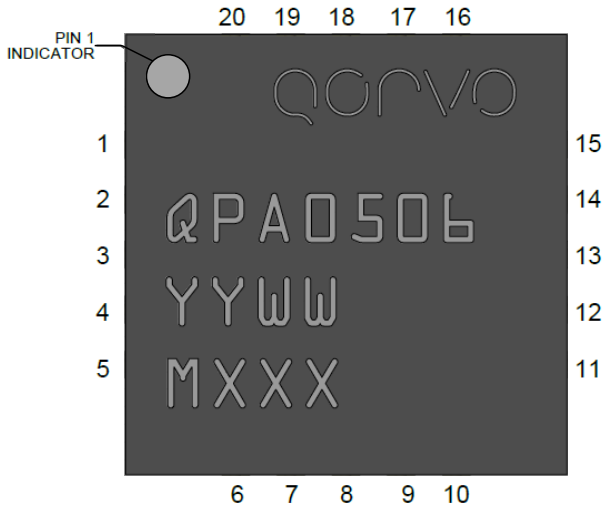

Pin Description

Pin Number	Symbol	Description
1, 2, 4, 5, 7-12, 14-18, 20	NC	No connection inside of package. Connection to PCB ground recommended
3	RF IN	RF input. 50 Ω , DC blocked
6	VG	Gate voltage. Bypass network required; refer to page 19
13	RF OUT	RF output. 50 Ω , DC blocked
19	VD	Drain voltage. Bypass network required; refer to page 19
21	GND	Center paddle ground

Evaluation Board

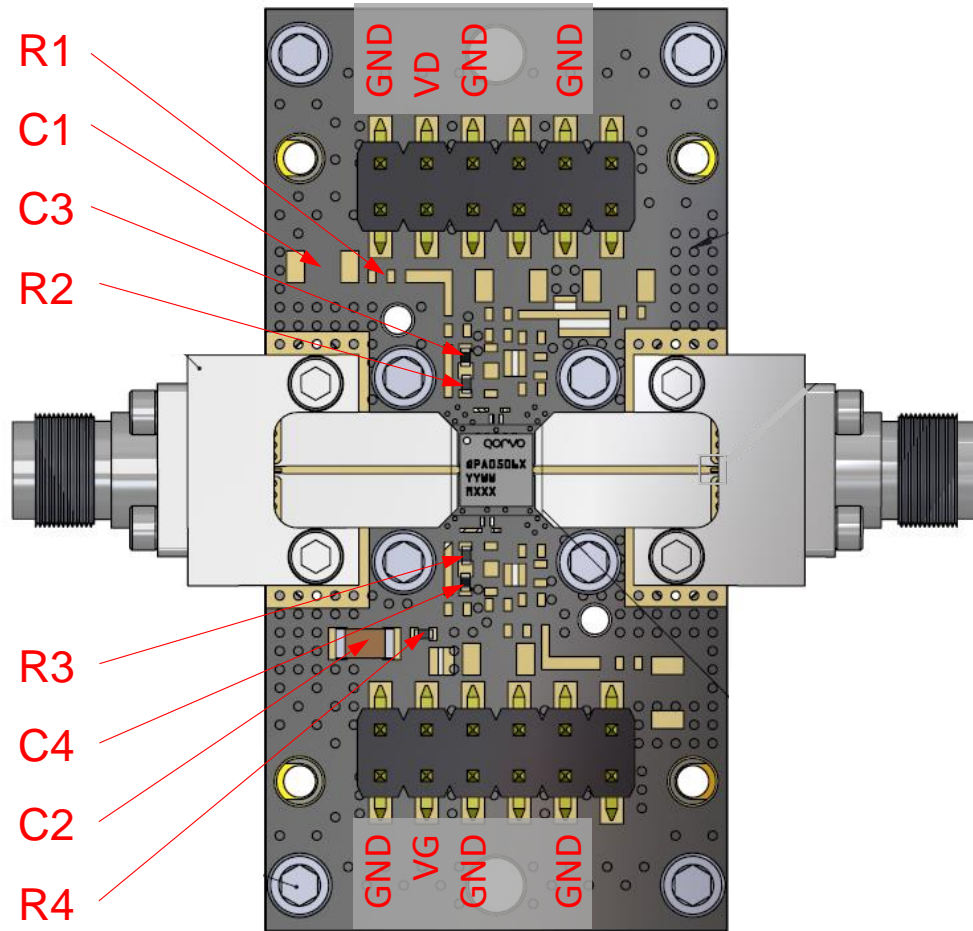

Bill of Materials

Ref. Des.	Value	Description	Manuf.	Part Number
C1*, C2	10 uF	CAP, 10uF, 20%, 50V, 20%, X5R, 1206	various	
C3,C4	1000 pF	CAP, 1000pF, 10%, 100V, X7R, 0402	various	
R1*, R2, R3, R4	10 Ω	RES, 10 OHM, 5%, 0.1W, 0402	various	
J1, J2	2.92 mm	2.92 mm Female End Launch Connector	Southwest Microwave	1092-01A-5

*Add C1 and R1 when operating in a linear power application

Mechanical Information

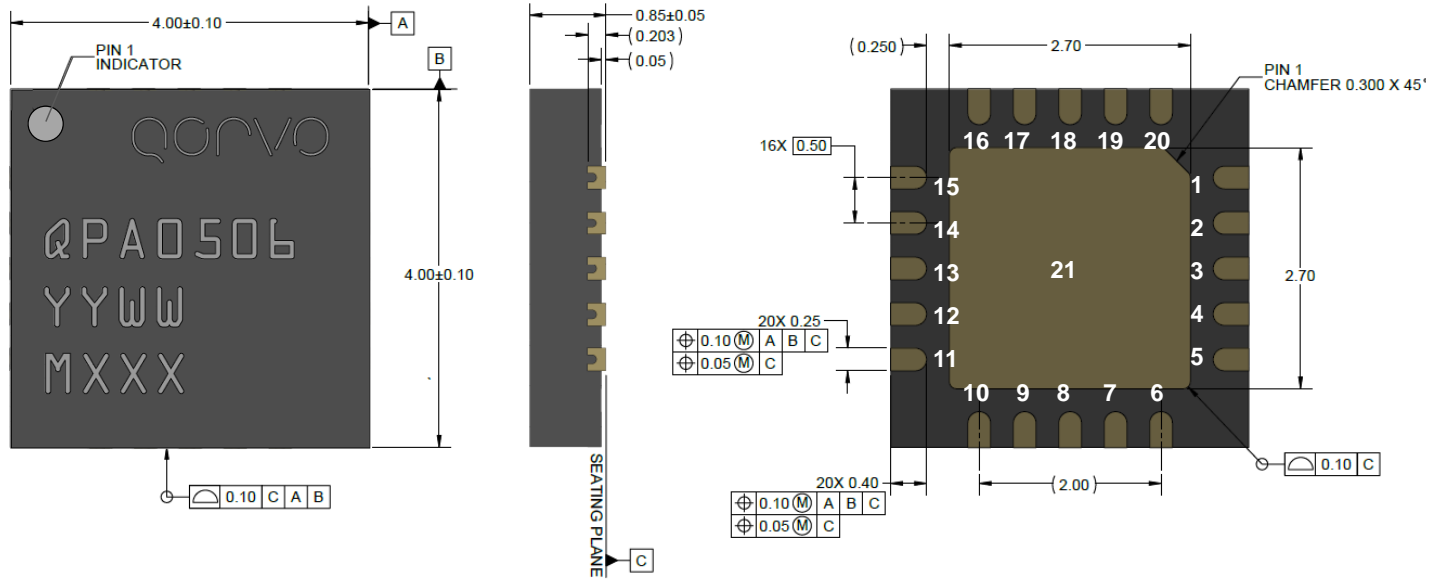

NOTES:
 Package base and leads are Ni-Au plated. Part is mold encapsulated.
 Part Markings:
 Part Number: QPA0506
 Part Assembly Year: YY
 Part Assembly Week: WW
 Lot Number: MXXX
 Dimensions are in millimeters

Assembly Notes

Compatible with lead-free soldering processes with 260°C peak reflow temperature.

Contact plating: Ni-Au.

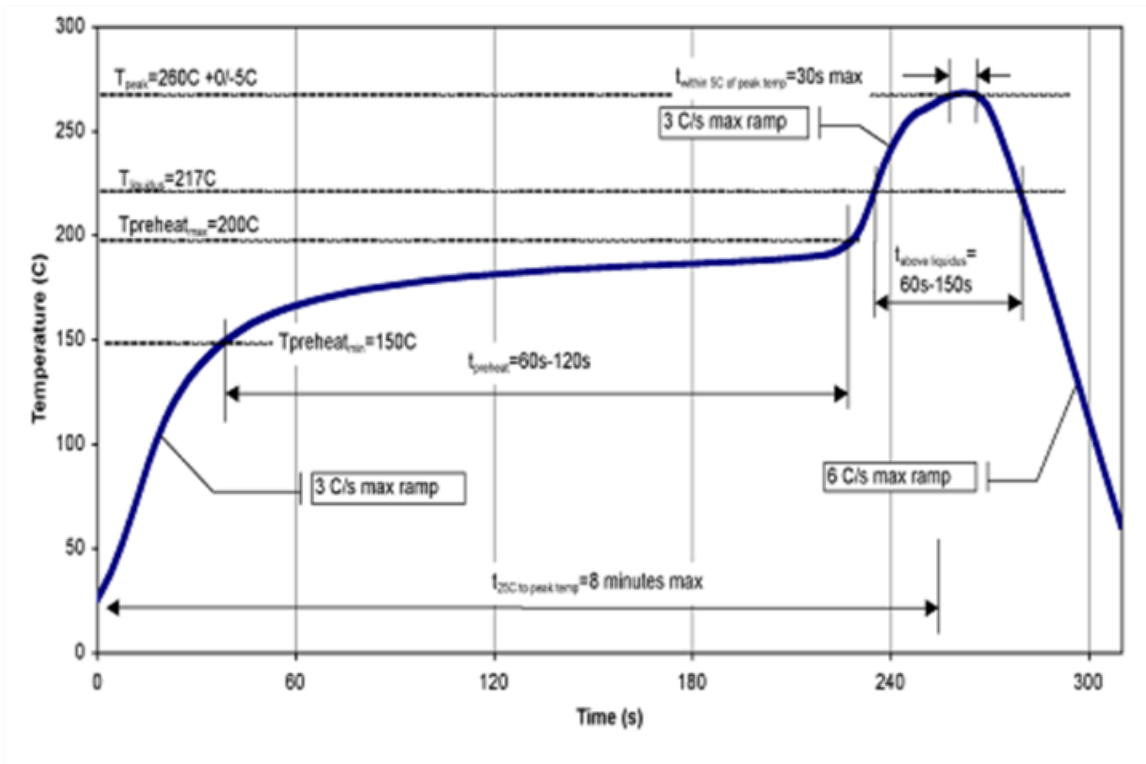

Recommended Soldering Temperature Profile

Tape and Reel Information – Carrier and Cover Tape Dimensions

Tape and reel specifications for this part are also available on the Qorvo website.
 Standard T/R size = 250 pieces on a 7" reel.

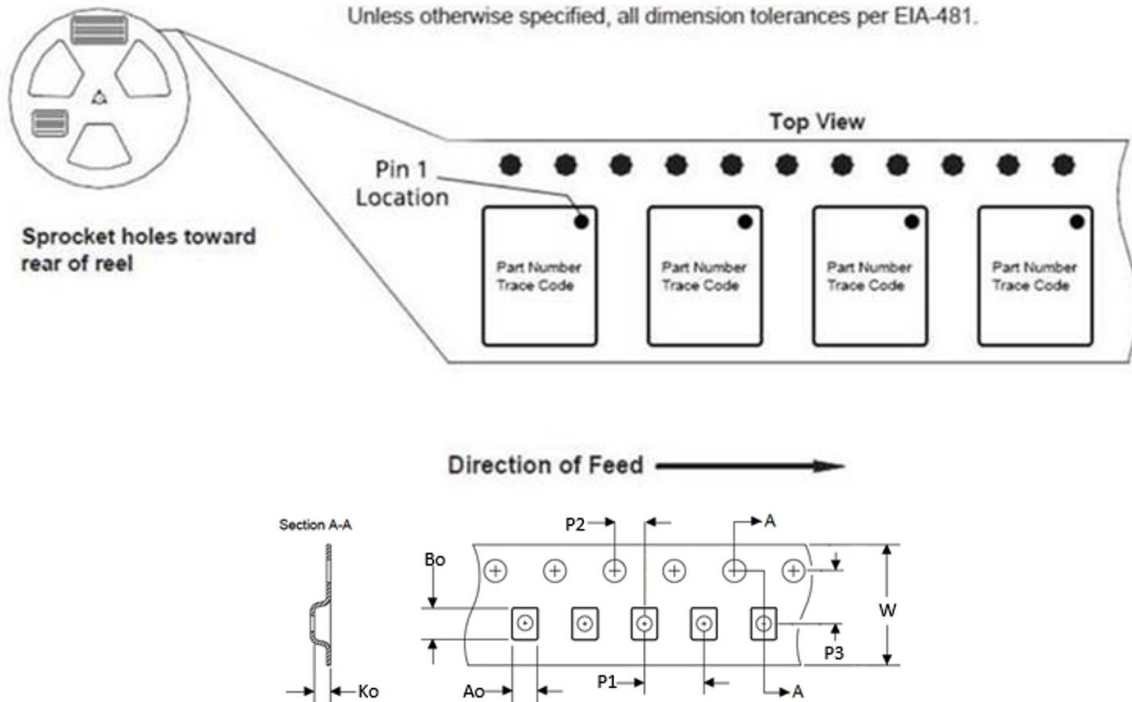

Feature	Measure	Symbol	Size (in)	Size (mm)
Cavity	Length	A0	0.169	4.30
	Width	B0	0.169	4.30
	Depth	K0	0.049	1.25
	Pitch	P1	0.315	8.00
Centerline Distance	Cavity to Perforation - Length Direction	P2	0.079	2.00
	Cavity to Perforation - Width Direction	F	0.217	5.50
Cover Tape	Width	C	0.362	9.20
Carrier Tape	Width	W	0.472	12.00

Tape and Reel Information – Reel Dimensions

Packaging reels are used to prevent damage to devices during shipping and storage, loaded carrier tape is typically wound onto a plastic take-up reel. The reel size is 7" diameter. The reels are made from high-impact injection-molded polystyrene (HIPS), which offers mechanical and ESD protection to packaged devices.

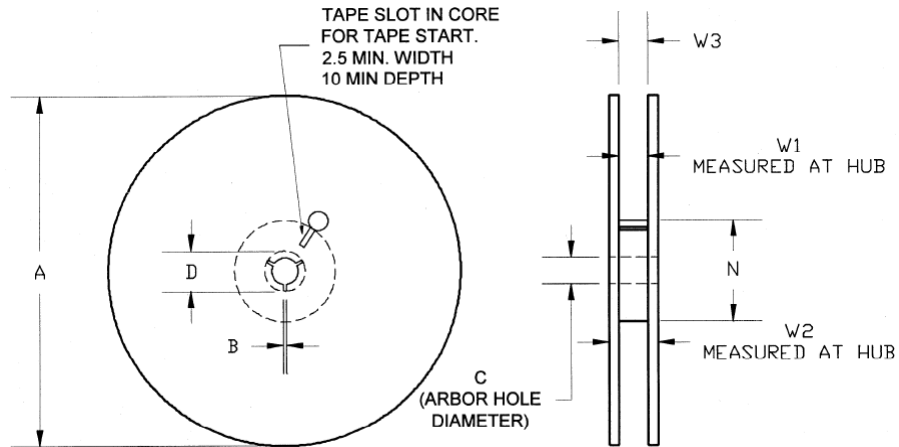

Feature	Measure	Symbol	Size (in)	Size (mm)
Flange	Diameter	A	6.969	177.0
	Thickness	W2	0.724	18.4
	Space Between Flange	W1	0.488	12.4
Hub	Outer Diameter	N	2.283	58.0
	Arbor Hole Diameter	C	0.512	13.0
	Key Slit Width	B	0.079	2.0
	Key Slit Diameter	D	0.795	20.2

Tape and Reel Information – Tape Length and Label Placement

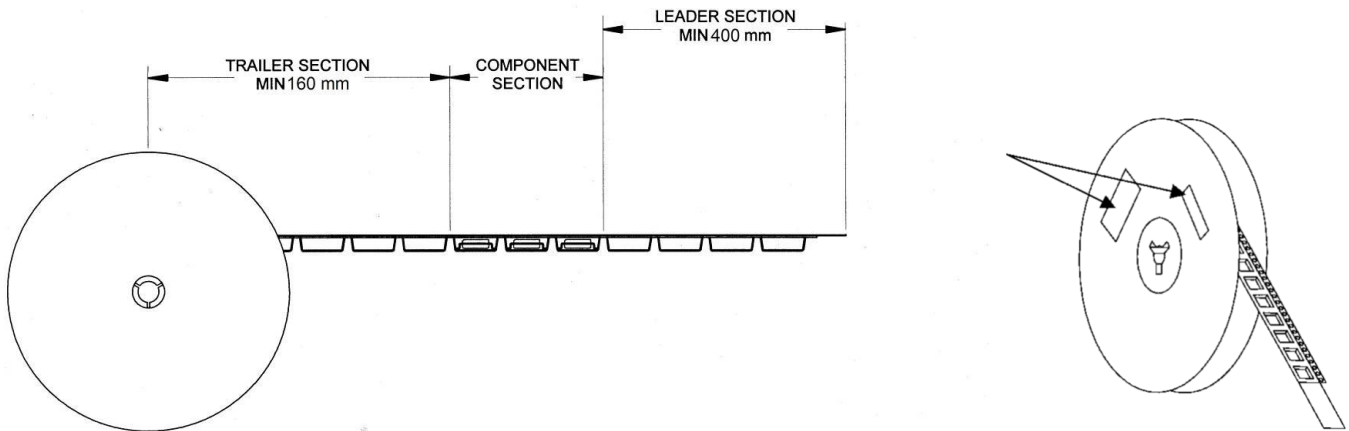

- Notes:
1. Empty part cavities at the trailing and leading ends are sealed with cover tape. See EIA 481-1-A.
 2. Labels are placed on the flange opposite the sprockets in the carrier tape.

Handling Precautions

Parameter	Rating	Standard
ESD – Human Body Model (HBM)	0B	ESDA / JEDEC JS-001-2014
ESD – Charged Device Model (CDM)	C1	ESDA / JEDEC JS-002-2017
MSL – Moisture Sensitivity Level	3	IPC/JEDEC J-STD-020



Caution!
ESD-Sensitive Device

RoHS Compliance

This part is compliant with 2011/65/EU RoHS directive (Restrictions on the Use of Certain Hazardous Substances in Electrical and Electronic Equipment) as amended by Directive 2015/863/EU.

This product also has the following attributes:

- Lead Free
- Halogen Free (Chlorine, Bromine)
- Antimony Free
- PFOS Free
- TBBP-A (C₁₅H₁₂Br₄O₂) Free
- SVHC Free

Contact Information

For the latest specifications, additional product information, worldwide sales and distribution locations:

Web: www.qorvo.com

Tel: 1-844-890-8163

Email: customer.support@qorvo.com

Important Notice

The information contained herein is believed to be reliable; however, Qorvo makes no warranties regarding the information contained herein and assumes no responsibility or liability whatsoever for the use of the information contained herein. All information contained herein is subject to change without notice. Customers should obtain and verify the latest relevant information before placing orders for Qorvo products. The information contained herein or any use of such information does not grant, explicitly or implicitly, to any party any patent rights, licenses, or any other intellectual property rights, whether with regard to such information itself or anything described by such information. **THIS INFORMATION DOES NOT CONSTITUTE A WARRANTY WITH RESPECT TO THE PRODUCTS DESCRIBED HEREIN, AND QORVO HEREBY DISCLAIMS ANY AND ALL WARRANTIES WITH RESPECT TO SUCH PRODUCTS WHETHER EXPRESS OR IMPLIED BY LAW, COURSE OF DEALING, COURSE OF PERFORMANCE, USAGE OF TRADE OR OTHERWISE, INCLUDING THE IMPLIED WARRANTIES OF MERCHANTABILITY AND FITNESS FOR A PARTICULAR PURPOSE.**

Without limiting the generality of the foregoing, Qorvo products are not warranted or authorized for use as critical components in medical, life-saving, or life-sustaining applications, or other applications where a failure would reasonably be expected to cause severe personal injury or death.

© 2022 Qorvo US, Inc. All rights reserved. This document is subject to copyright laws in various jurisdictions worldwide and may not be reproduced or distributed, in whole or in part, without the express written consent of Qorvo US, Inc.